

Technical Note

— Judicious Use of Aluminum Electrolytic Capacitors —

Contents

1. Overview of Aluminum Electrolytic Capacitors

- 1 – 1 Basic Model of Aluminum Electrolytic Capacitors
- 1 – 2 Structure of Aluminum Electrolytic Capacitors
- 1 – 3 Features of Capacitor Materials
- 1 – 4 Manufacturing process

2. Basic Performance

- 2 – 1 Basic Electrical Characteristics
- 2 – 2 Frequency Characteristics of Impedance

3. Reliability

4. Failure Modes

5. Lifetime of Aluminum Electrolytic Capacitors

- 5 – 1 Ambient Temperature Effect on Lifetime
- 5 – 2 Applying Voltage Effect on Lifetime
- 5 – 3 Ripple Current Effect on Lifetime
- 5 – 4 Charge and Discharge Operation Effect on Lifetime
- 5 – 5 Inrush Current
- 5 – 6 Abnormal Voltage Effect on Lifetime

6. Effect of Halogens

- 6 – 1 Effect of Flux
- 6 – 2 Cleaning Agents
- 6 – 3 Adhesive and Coating Materials
- 6 – 4 Effect of Fumigation

7. Recovery Voltage

8. Storage

9. Tips for Selecting Capacitors Appropriate for Individual Applications

- 9 – 1 Input Filtering Capacitors for Switching Mode Power Supplies
- 9 – 2 Output Filtering Capacitors for Switching Mode Power Supplies
- 9 – 3 Filtering Capacitors for Inverter Main Circuits
- 9 – 4 Capacitors for Control Circuits
- 9 – 5 Photoflash Capacitors

1. Overview of Aluminum Electrolytic Capacitors

1-1 Basic Model of Aluminum Electrolytic Capacitors

Capacitors are passive components. Among the various kinds of capacitors, aluminum electrolytic capacitors offer larger CV product per case size and lower cost than the others.

In principles of capacitor, its fundamental model is shown in Fig. 1 and its capacitance (C) is expressed by Equation (1) below:

$$C = 8.854 \times 10^{-12} \frac{\epsilon S}{d} \text{ (F)} \dots\dots\dots(1)$$

- ϵ : Dielectric constant
- S : Surface area of dielectric (m²)
- d : Thickness of dielectric (m)

Equation (1) shows that the capacitance (C) increases as the dielectric constant (ϵ) and/or its surface area (S) increases and/or the dielectric thickness (d) decreases.

An aluminum electrolytic capacitor comprises a dielectric layer of aluminum oxide (Al₂O₃), the dielectric constant (ϵ) of which is 8 to 10. This value is not significantly larger than those of other types of capacitors.

However, by extending the surface area (S) of the aluminum foil electrode by means of etching, and by electrochemically forming a thinner but highly voltage-withstandable layer of oxide layer dielectric, the aluminum electrolytic capacitor can offer a larger CV product per case size than other types of capacitors.

A basic model of aluminum electrolytic capacitor is shown in Fig. 2. An aluminum electrolytic capacitor comprises:

- Anode ...Aluminum foil
- Dielectric...Electrochemically formed oxide layer (Al₂O₃) on the anode
- Cathode ...A true cathode is electrolytic solution (electrolyte).

Other component materials include a paper separator that holds electrolyte in place and another aluminum foil that functions as a draw-out electrode coming into contact with the true cathode (electrolyte).

In general, an aluminum electrolytic capacitor is asymmetrical in structure and polarized. The other capacitor type known as a bi-polar (non-polar) comprises the anodic aluminum foils for both electrodes.

1-2 Structure of Aluminum Electrolytic Capacitor

The aluminum electrolytic capacitor has, as shown in Fig. 3, a roll of anode foil, paper separator, cathode foil and electrode terminals (internal and external terminals) with the electrolyte impregnated, which is sealed in an aluminum can case with a sealing material.

The terminal draw-out structure, sealing material and structure differ depending on the type of the capacitor. Figure 4 shows typical examples.

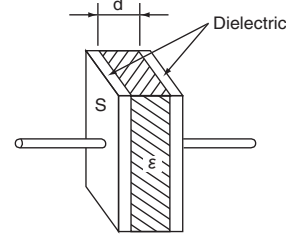
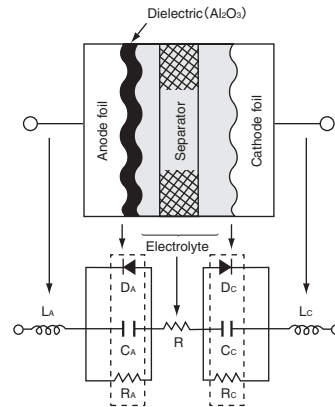

Fig-1 Basic model of capacitor



- C_A, C_C : Capacitance due to anode and cathodes foils
- D_A, D_C : Diode effects due to oxide layer on anode and cathode foils
- L_A, L_C : Inductance due to anode and cathode terminals
- R : Resistance of electrolyte and separator
- R_A, R_C : Internal resistance of oxide layer on anode and cathode foils

Fig-2 Basic model and equivalent circuit of aluminum electrolytic capacitor

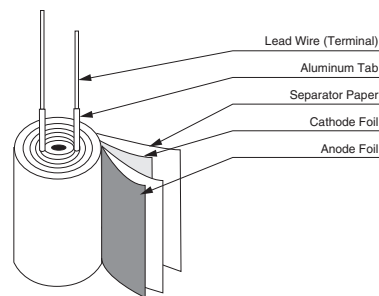

Fig-3 Basic model of element

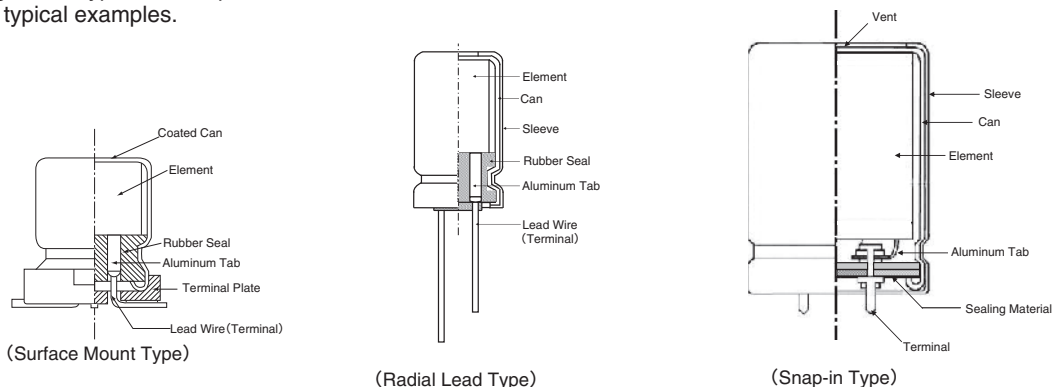

Fig-4 Construction of Aluminum Electrolytic Capacitors

1-3 Features of Capacitor Materials

Aluminum, which is main material in an aluminum electrolytic capacitor, forms an oxide layer (Al_2O_3) on its surface when the aluminum is set as anode and charged with electricity in electrolyte.

The aluminum foil with an oxide layer formed thereon, as shown in Fig. 5, is capable of rectifying electric current in electrolyte. Such a metal is called a valve metal.

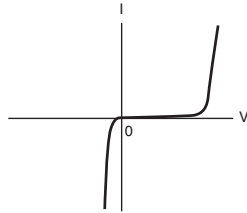

Fig-5 V-I characteristics of aluminum oxide

<Anode aluminum foil>

First, the foil material is electromechanically etched in a chloride solution to extend the surface area of the foil.

Secondly, for the foil to form an aluminum oxide layer (Al_2O_3) as a dielectric, more than the rated voltage is applied to the foil in a solution such as ammonium borate. This dielectric layer is as dense and thin as 1.1 - 1.5 nm/volt and showing a high insulation resistance ($10^8 - 10^9 \Omega/m$).

The thickness of the oxide layer determines the withstand voltage according to their direct proportional relationship. For the etching pits to be shaped to the intended thickness of the oxide layer, the pit patterns have been designed to have efficient surface area extension depending on the intended withstand voltage (see Fig. 6)

<Cathode aluminum foil>

An etching process is performed to the cathode aluminum foil as well as the anode foil. However, the formation process for oxide layer is generally not performed. Therefore, the surface of the cathode foil only has an oxide layer (Al_2O_3) that has spontaneously formed, which gives a withstand voltage of about 0.5 volt.

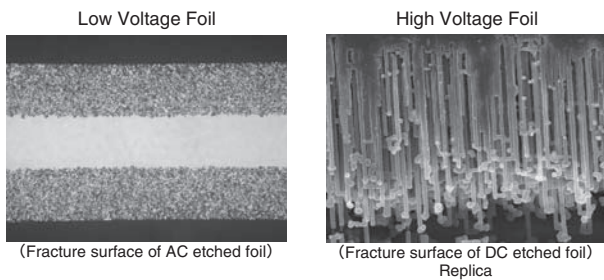

Fig-6 Cross section of aluminum etched foil (SEM)

<Electrolyte>

The electrolyte, an ion-conductive liquid functions as a true cathode coming into contact with the dielectric layer on the surface of the anode foil. The cathode foil serves as a collector electrode to connect the true cathode with the external circuit. Electrolyte is an essential material that controls the performance of the capacitor (temperature characteristics, frequency characteristics, service life, etc.).

<Paper separator >

The separator maintains uniform distribution of the electrolyte and keeps the anode-to-cathode foil distance unchanged.

<Can case and sealing materials>

An aluminum can case and seal materials mainly consisting of rubber are used for the purpose of keeping airtightness.

1-4 Manufacturing Process

① Etching (for extending the surface area)

This etching process serves to extend the surface area of the aluminum foil. This is an AC or DC current-employed electrochemical process for etching the foil surface in a chloride solution.

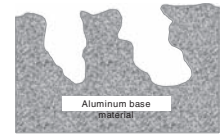

Etching Model

② Formation (for forming a dielectric)

This is a process for forming a dielectric layer (Al_2O_3), which is normally performed on the anode aluminum foil.

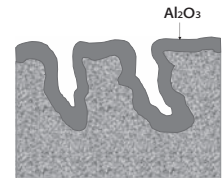

Forming Model

③ Slitting

This is a process for slitting aluminum foils (both the anode and cathode) and paper separators to the specified product size.

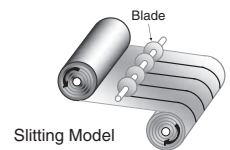

Slitting Model

④ Winding

This is a process for rolling a set of anode and cathode foils into a cylindrical form with a paper separator inserted between them. During this process, an inner terminal (called a tab) is attached to each of the aluminum foils. The roll made at this process is called a capacitor element.

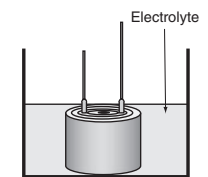
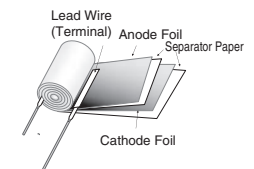

Impregnation

⑤ Impregnation

This is a process for impregnating the element with electrolyte as a true cathode. The electrolyte also functions to repair the dielectric layer.

⑥ Sealing

This process seals the element using the aluminum can case and sealing materials (rubber, rubber-lined cover, etc.) for keeping the case airtight.

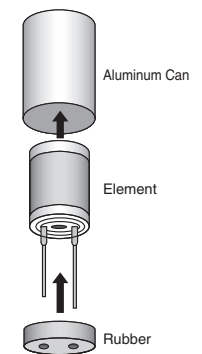

⑦ Aging (reforming)

The process of applying voltage to a post-sealed capacitor at high temperature is called "aging". This serves to repair defective dielectrics that have been made on the foil during the slitting or winding process.

⑧ 100% inspection and packaging

After the aging, all products shall undergo testing for checking their electrical characteristics with chip termination, lead reforming, taping etc. finished, and then be packaged.

⑨ Outgoing inspections

Outgoing inspections are performed as per standard inspection procedures.

⑩ Shipment

2. Basic Performance

2-1 Basic Electrical Characteristics

2-1-1 Capacitance

The larger the surface area of an electrode is, the higher the capacitance (capacity for storing electricity) is. For aluminum electrolytic capacitors, the capacitance is measured under the standard measuring conditions of 20°C and a 120Hz AC signal of about 0.5V. Generally, as the temperature rises, the capacitance increases; as the temperature decreases, the capacitance decreases (Fig. 7). With a higher frequency, the capacitance is smaller; with a lower frequency, the capacitance is larger (Fig. 8).

2-1-2 $\tan \delta$ (also called tangent of loss angle or dissipation factor)

(Fig. 9) is a simplified model of the equivalent circuit shown in (Fig. 2). For an ideal capacitor with an equivalent series resistance of $R = 0$, the $\tan \delta$ shown in (Fig. 10) is zero. For an aluminum electrolytic capacitor, the equivalent series resistance (R) is not zero due to the presence of resistance of the electrolyte and paper separator and other contact resistances. $1/\omega C$ and R are correlated as shown in (Fig. 10) and Equation (2).

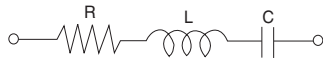

Fig-9 Simplified equivalent circuit

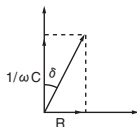

Fig-10 Dissipation Factor ($\tan \delta$)

$$\tan \delta = \frac{R}{1/\omega C} = \omega CR \dots\dots\dots (2)$$

$$\omega : 2\pi f$$

$$\pi = \text{Circular constant, } f : \text{Frequency (} f = 120\text{Hz)}$$

2-1-3 Leakage Current (LC)

As a feature of an aluminum electrolytic capacitor, when DC voltage is applied to it, the oxide layer that acts as a dielectric in the electrolyte allows a small amount of electric current to flow in it. The small amount of current is called a leakage current (LC). An ideal capacitor does not allow the leakage current to flow (this is not the case for charging current).

The leakage current (LC) changes with time as shown in (Fig. 12). Note that LC, decreasing with time, will reach a steady-state value. Therefore, the specifications of LC are defined as a value measured several minutes after the beginning of the application of the rated voltage at 20°C. As the temperature rises, the LC increases; as the temperature decreases, the LC decreases (Fig.13). As the applied voltage decreases, the LC decreases.

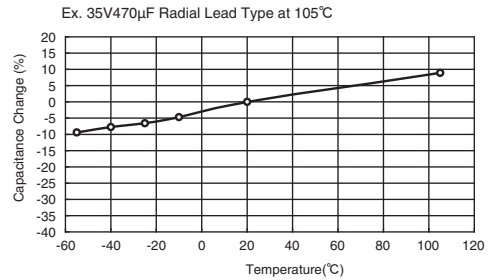

Fig-7 Temperature Characteristics of Capacitance

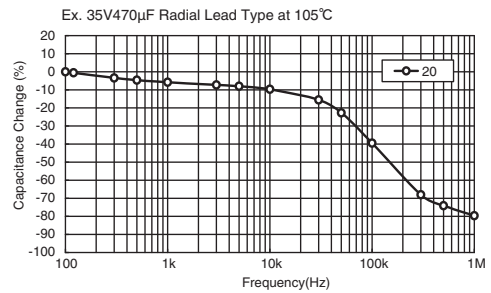

Fig-8 Frequency Characteristics of Capacitance

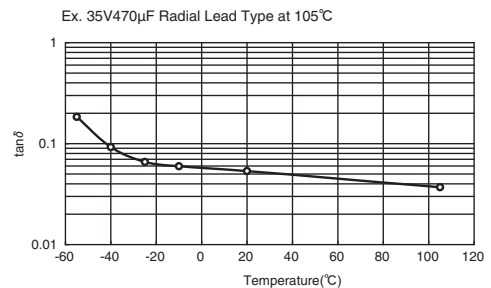

Fig-11 Temperature Characteristics of $\tan \delta$

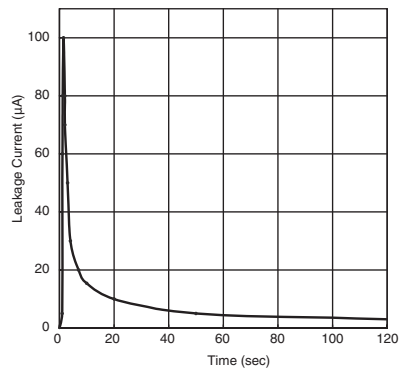

Fig-12 Leakage Current vs. Time

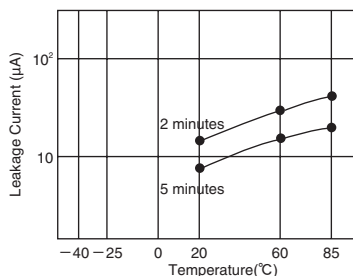

Fig-13 Temperature Characteristics of Leakage Current

2-2 Frequency Characteristics of Impedance

When a capacitor is applied with a voltage with the frequency changed, the impedance (Z), a factor of preventing the AC current changes as shown in (Fig. 14). This is the impedance-frequency characteristics of the capacitor.

(Fig. 9) is a simplified model of an equivalent circuit of an aluminum electrolyte capacitor. (Fig. 14) shows dotted lines representing a breakdown of the impedance-frequency characteristic curve into components (C, R and L). As can be seen in this figure, the impedance-frequency characteristics are a composition of C, R and L frequency characteristics.

The value $1/\omega C$ shows the pure capacitive reactance graphically presented by a straight line going downward at an angle of 45° , and ωL shows the pure inductive reactance graphically presented by a straight line going upward at 45° . R shows the equivalent series resistance (ESR). At a range of lower frequencies, the R curve goes downward due to the dielectric loss frequency-dependence. At a range of higher frequencies, the R curve tends to be almost flat since resistance of electrolyte and paper separator is dominant and independent on frequency. Equation (3) shows this tendency.

$$Z = \sqrt{R^2 + \left(\omega L - \frac{1}{\omega C}\right)^2} \dots\dots\dots (3)$$

Because the impedance characteristics of an aluminum electrolyte capacitor depend on resistance of the electrolyte and paper separator, the Z value at the self-resonant frequency tends to be relatively higher, as shown by the solid line in (Fig. 15). The resistance of the electrolyte varies depending on temperature: as the temperature rises, the impedance decreases; and as the temperature decreases, the impedance increases, as shown in (Fig. 16).

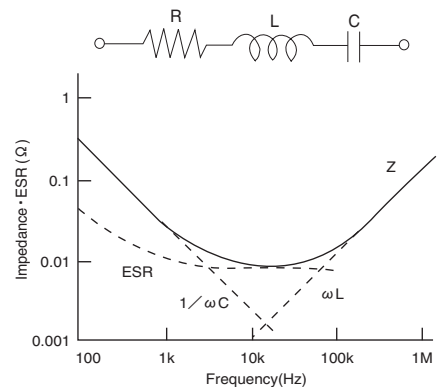

Fig-14 Factor of Impedance Frequency

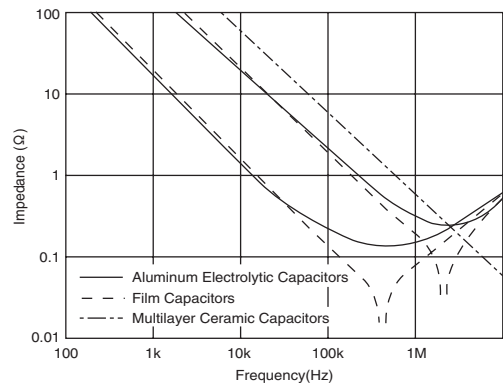

Fig-15 Frequency Characteristics of each Capacitors Impedance

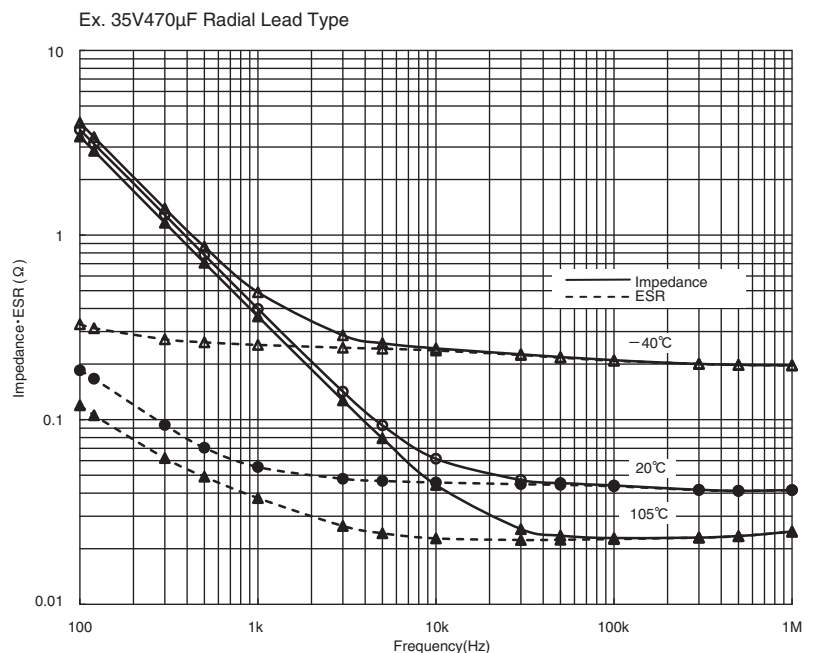

Fig-16 Temperature and Frequency Characteristics of Impedance · ESR

3. Reliability

For designing the device with aluminum electrolytic capacitors, a failure rate and useful life are necessary to be considered for their reliability. The failure rate of aluminum electrolytic capacitors is approximated by the bathtub curve shown in (Fig.17).

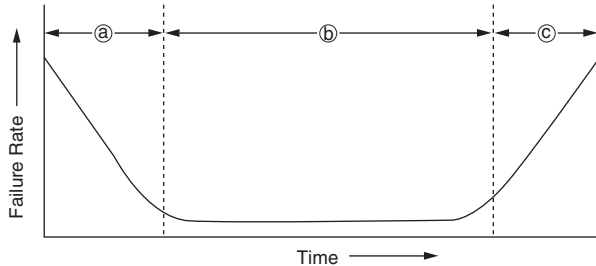

Fig-17 Bathtub curve

- (a) **Early failure period**
At the comparatively early periods of use, devices/components fail by deficiencies in design or manufacturing process or incompatibility with operation conditions. For aluminum electrolytic capacitors, these defectives are removed by debugging at one of manufacturing processes before shipments.
- (b) **Random failure period**
Failure is stable low in occurrence and appears unrelated to their served term. Aluminum electrolytic capacitors are low in catastrophic failures in this period compared with semi-conductors and solid tantalum capacitors.
- (c) **Wear-out failure period**
In this period, the failure rate increases with the served time. For aluminum electrolytic capacitors, since they were completed in manufacturing, the electrolyte impregnated has gradually evaporated and diffused out of the capacitors through the rubber seal materials with time, which leads to decrease in the capacitance and/or increase $\tan\delta$. When any of these values changes beyond the allowable range of specifications, the capacitors are defined as "fell into the wear-out failure". The served term until the capacitors fall into the wear-out failure period is called a useful life.

Aluminum electrolytic capacitors have two categories of failures: catastrophic failure and wear-out failure.

<Catastrophic failure>

This is a failure mode that completely destroys the function of the capacitor such as short circuit and open circuit failure.

<Wear-out failure>

This is a failure mode where the electrical parameters of the capacitor gradually deteriorate and fail. The criteria for determining if this failure has occurred depend on the purpose of a device. For each series of capacitors, the following electrical parameters have been defined as criteria in the specifications of Endurance in the catalogs or product specifications:

- Change in capacitance
- $\tan\delta$
- Leakage current

Failure rates are often measured in units of % per 1000 hours ($10^{-5}/\text{hour}$). For higher reliability devices designed with a smaller failure rate, units of Failure In Time (FIT) ($10^{-9}/\text{hour}$) is used.

Aluminum electrolytic capacitors are considered as components of wear-out failure mode, the electrical characteristics of which gradually deteriorate and their failure rate increases with time. In general, the failure rate in FIT is determined by total component-hours (product of the number of tested components and test hours).

Due to the definition of FIT, the same FIT rate can be calculated in both cases of testing on the large number of tested components and also testing for long test periods of time. However, these cases mean differently for aluminum electrolytic capacitors. Using the failure rate is not suited to express the reliability of aluminum electrolytic capacitors, but the electrical characteristics based lifetime in hour should be considered to express the reliability.

Also, there are MTBF (Mean Time Between Failures) and MTTF (Mean Time To Failure) to express reliability. The latter is applicable for aluminum electrolytic capacitors because they are categorized into a group of non-repairable systems, equipment and devices for which MTTF is applicable.

4. Failure Modes

Failure modes depend on the application conditions that lead to fail. (Fig. 18).

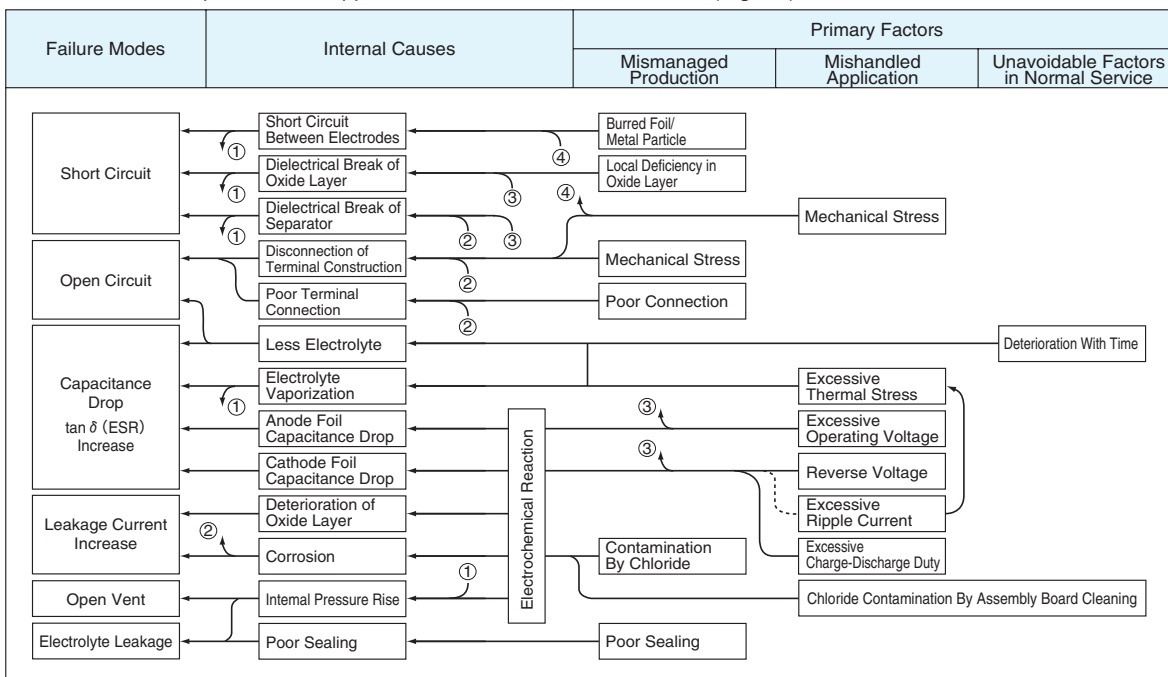

Fig-18 Failure Modes

5. Lifetime of Aluminum Electrolytic Capacitors

The lifetime of aluminum electrolytic capacitors is largely dependent on the application conditions. Environmental factors include temperature, humidity, atmospheric pressure and vibrations. Electrical factors include operating voltage, ripple current and charge-discharge. Where the capacitors are used in a normal filtering circuit, ambient temperature and heating due to the ripple current are crucial factors for determining the lifetime of the capacitors. These factors are included to the lifetime specifications titled "Endurance" on the catalogs or product specifications. For applications subject to high humidity and/or continuous vibrations, or subject to frequent charge and discharge operations, the endurance of individual conditions should be considered.

5-1 Ambient Temperature Effect on Lifetime

The lifetime of aluminum electrolytic capacitors is affected mainly by the loss of electrolyte as the result of diffusion through the rubber seal materials, which leads to a decrease in capacitance and increase in $\tan\delta$.

The relationship of temperature to the diffusion of electrolyte follows the Arrhenius' Law (Equations (4) and (5)):

$$k = Ae^{\frac{-E}{RT}} \dots\dots\dots (4)$$

$$\ln k = \left(\frac{-E}{RT} \right) + \ln A \dots\dots\dots (5)$$

- k : Reaction rate constant
- A : Frequency factor
- E : Activation energy
- R : Gas constant (8.31J/deg)
- T : Absolute temperature (K)

Applying Equation (5) to the lifetime of the capacitors brings Equation (6), which is converted to Equation (7):

$$\log\left(\frac{L_x}{L_o}\right) = \frac{E}{2.303R} \left(\frac{1}{T_x} - \frac{1}{T_o} \right) \dots\dots\dots (6)$$

$$\log L_x = \frac{E}{2.303R} \left(\frac{1}{T_x} - \frac{1}{T_o} \right) + \log L_o \dots\dots\dots (7)$$

Practical estimation of the lifetime has been using Equation (8) as an approximation:

$$L_x = L_o \cdot Bt^{(T_o - T_x)/10} \dots\dots\dots (8)$$

L_o : Specified lifetime (hour) with the rated voltage applied (or the rated ripple current superimposed to a DC voltage) at the upper limit of the category temperature. Refer to the lifetime specifications of individual products.

- L_x : Estimated life on actual usage (hour)
- T_o : Maximum Category Temperature (°C)
- T_x : Actual Ambient Temperature (°C)
- Bt : Temperature acceleration factor

Where, the temperature acceleration factor (BT) is approximately 2 over an ambient temperature range from 60°C to 95°C, which means that the lifetime is approximately halved for every 10°C rise in ambient temperature. However, according to the Arrhenius Equation (6), the reciprocal of T is directly proportional to the logarithm of lifetime, which means that, strictly speaking, there is the temperature range where the theory of lifetime reducing by half at every 10°C rise is not applied. (Fig. 19).

Especially for capacitors whose maximum operating temperature is a 105°C or higher, the temperature acceleration factor (BT) needs to be modified depending on temperature ranges of the lifetime estimation. For details, please consult us.

For lifetime estimation at a lower-temperature range, evaluation test data have not been obtained, and for evaluating long term endurance, it is necessary to take into account some additional factors such as deterioration of the rubber seal materials as well as the diffusion of electrolyte. Accordingly, in Equation (8), T_x should be 40°C at the lowest for the lifetime calculation purpose, and also the estimated lifetime (L_x) should be 15 years at the longest.

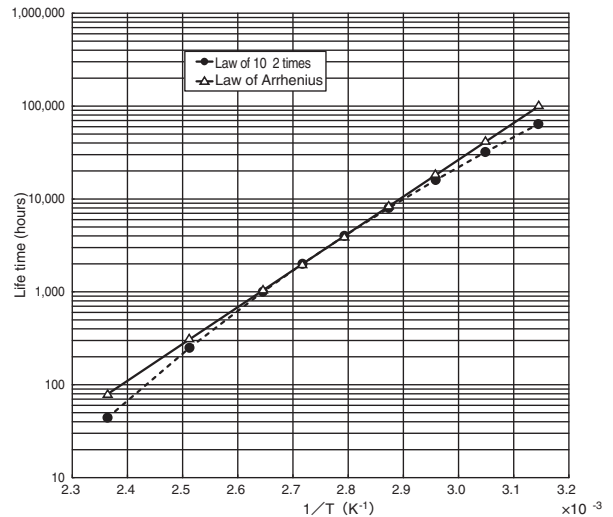

Fig-19 Estimated result by Law of 10°C 2 times and Law of Arrhenius

5-2 Applying Voltage Effect on Lifetime

Where a capacitor is used at lower than the rated voltage, the lifetime may not be adversely affected, which means that the effect of the applying voltage is negligibly small, while the effect of the ambient temperature and heat generation due to ripple current is significant.

(Fig-20)

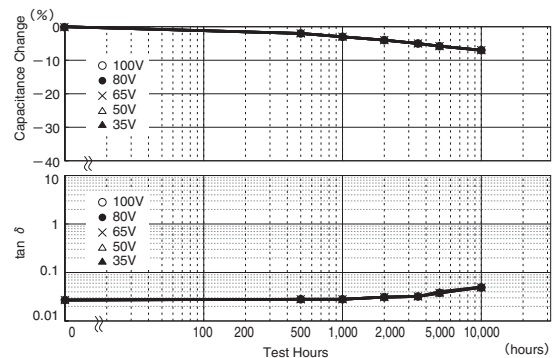

Fig-20 Endurance (measured by each apply voltage, result curves are overlapped)
Note: Due to the very small effect of the applying voltages, the plots cannot be distinguished from one another.

However, for capacitors of larger size and higher rated voltage contain a larger volume of electrolyte, difference in applying voltages can affect degradation of the oxide layer, other than the diffusion of electrolyte.

Therefore, for screw mount terminal type capacitors with the rated voltage of 350Vdc or higher, the lifetime estimation includes the effect of applying a lower voltage than the rated voltage (derating voltage).

5-3 Ripple Current Effect on Lifetime

Since an aluminum electrolytic capacitor has a larger $\tan\delta$ than other types of capacitors, the capacitor produces more internal heat when a ripple current flows through it. The temperature rise due to this heat may significantly affect the lifetime of the capacitor. This is the reason why ripple current ratings are specified for capacitors.

5-3-1 Heat Generation due to Ripple Current

Power consumption by the ripple current can be expressed as follows:

$$W = I_R^2 R + V I_L \dots\dots\dots (9)$$

- W : Internal power dissipation
- I_R : Ripple Current
- R : Internal Resistance (Equivalent Series Resistance)
- V : Applied voltage
- I_L : Leakage Current

Leakage current I_L at the maximum operating temperature can be 5 to 10 times higher than the values measured at 20°C. However, considering $I_R \gg I_L$, the above equation can be simplified as Equation (10).

$$W \approx I_R^2 R \dots\dots\dots (10)$$

To obtain the temperature at which equilibrium is achieved between heat generation and dissipation, derive Equation (11).

$$I_R^2 R = \beta A \Delta T \dots\dots\dots (11)$$

- β : Radiation Constant
- A : Surface area of can case (m^2)
- ΔT : Temperature-rise due to the Ripple Current(°C)
- $A = \frac{\pi}{4} D(D + 4L)$
- D : Can Diameter (m)
- L : Can Length (m)

From the above equation, the internal temperature rise (ΔT) is given by Equation (12):

$$\Delta T = \frac{I_R^2 R}{\beta A} \dots\dots\dots (12)$$

Also, for a ripple frequency of 120Hz, Equation (12) for calculating ΔT is rewritten as Equation (13):

$$\Delta T = \frac{I_R^2 R}{\beta A} = \frac{I_R^2 \tan \delta}{\beta A \omega C} \dots\dots\dots (13)$$

Where $R = \frac{\tan \delta}{\omega C}$

- $\tan \delta$: Dissipation Factor at 120Hz
- ω : $2 \pi f$ ($f = 120\text{Hz}$)
- C : Capacitance at 120Hz(F)

An approximate value of ripple current-caused ΔT can be calculated using Equation (14):

$$\Delta T = (I_x/I_o)^2 \times \Delta T_o \dots\dots\dots (14)$$

- I_o : Rated ripple current (Arms), frequency compensated, at the upper limit of the category temperature range
- I_x : Operating ripple current (Arms) actually flowing in the capacitor
- ΔT_o : Rise in internal temperature due to the rated ripple current (°C): different for each product series. Please consult us.

There are some product families that can accept a higher ripple current than the rated value providing that ambient temperature T_x is lower than the upper limit of the category temperature range. However, in this case, remember that the lifetime decreases due to the higher ΔT due to the ripple current. Be sure that ΔT does not exceed the specified limit that has been determined as a function of ambient temperature. Note that the core temperature limit of the element is shown by [$T_x + \Delta T$ limit].

Examples of ΔT limits at some ambient temperatures are shown below.

Ambient Temp T_x	85°C less or equal	105°C
Limit value of ΔT	15°C	5°C

Each product family has a different ΔT limit. For details, consult us.

5-3-2 Ripple Current and Frequency

The ripple current rating is specified normally by the effective value (r.m.s value) of 120Hz or 100kHz sine wave. However, since the equivalent series resistance

(ESR) of a capacitor is frequency-dependent, the allowable ripple current depends on the frequency. Where the operating ripple current consists of a mains power frequency element and switching frequency element(s) like switching mode power supplies do, the internal power loss is expressed by Equation (15):

$$W = I_{r1}^2 R_{r1} + I_{r2}^2 R_{r2} + \dots\dots I_{rn}^2 R_{rn} \dots\dots\dots (15)$$

- W : Power consumption
- $I_{r1}, I_{r2}, \dots, I_{rn}$: Ripple current (Arms) at frequency $f_1 \dots f_n$
- $R_{r1}, R_{r2}, \dots, R_{rn}$: ESR (Ω) at $f_1 \dots f_n$

Given a frequency compensation factor (Frequency Multiplier) = F_{fn} and reference frequency for the ripple current = f_o , $R_{fn} = R_o/F_{fn}^2$ is obtained. Therefore, the ripple current at any frequency can be converted into its r.m.s. value at the reference frequency (I_{fo}) using Equation (16):

$$I_{fo} = \sqrt{(I_{f1}/F_{f1})^2 + (I_{f2}/F_{f2})^2 + \dots\dots (I_{fn}/F_{fn})^2} \dots\dots\dots (16)$$

- I_{fo} : Reference ripple current (Arms), i.e., that at the reference frequency
- $F_{f1}, F_{f2}, \dots, F_{fn}$: Frequency compensation factor (Frequency Multiplier) at frequency $f_1 \dots f_n$ (Refer to the catalogs)

Note that the ESR depends on the temperature and the value of β depends on the installation conditions of the capacitor on the board. To determine more accurate values of ΔT , they can be actually measured using a thermocouple.

5-3-3 Lifetime Estimation

Equations (17) through (19) can be used for estimating the lifetime of a non-solid aluminum electrolytic capacitor based on the ambient temperature, the rise of internal temperature due to ripple current, and operating voltage applied.

For a surface mount type or radial lead type capacitor :
Endurance specifications are defined by the rated voltage.

$$L_x = L_o \times 2^{\frac{T_o - T_x}{10}} \times 2^{\frac{-\Delta T}{5}} \dots\dots\dots (17)$$

For a surface mount type or radial lead type capacitor : Endurance specifications are defined by "the rated ripple current superimposition".

$$L_x = L_r \times 2^{\frac{T_o - T_x}{10}} \times 2^{\frac{\Delta T_o - \Delta T}{5}} \dots\dots\dots (18)$$

For a snap-in type or screw terminal type capacitor

$$L_x = L_r \times 2^{\frac{K(T_o - T_x)}{10}} \times 2^{\frac{\Delta T_o - \Delta T}{A}} \times K_v \dots\dots\dots (19)$$

- L_o : Specified lifetime (hour) at the upper limit of the category temperature range and at the rated voltage
- L_r : Specified lifetime (hour) at the upper limit of the category temperature range and at the rated ripple current superimposed to a DC voltage
- L_x : Estimation of actual lifetime (hour)
- T_o : Upper limit of the category temperature range (°C)
- T_x : Actual ambient temperature of the capacitor (°C)
Use 40°C if the actual ambient temperature is below it.
- ΔT : Rise of internal temperature due to actual ripple current (°C)
- * ΔT_o : Rise of internal temperature due to the rated ripple current (°C)
- * K_t : Correction factor of ambient temperature acceleration factor
- * K_v : Derating voltage factor (a snap-in type capacitor with the rated voltage of less than 160V_{dc} and a screw terminal type capacitor with the rated voltage of less than 350V_{dc} :1)
- * A : Acceleration factor of temperature-rise due to the ripple current (This factor depends on use conditions.)

For the values marked with *, consult us.

Please consult us about lifetime equations for the series of the category temperature 125°C or more.

Subject series : MXB, MHS, MVH, MHL, MHB, MHJ, MHK, GPA, GVA, GXF, GXE, GXL, GPD, GVD, GQB, GXA.

Note that the calculation results above are not considered as a guaranteed value. When designing the lifetime of a device, please select a capacitor that has an extra margin against the device lifetime requirements. Also, where the estimation result calculated exceeds 15 years, please consider 15 years to be a maximum. If 15 years or more may be required as an expected lifetime, please consult us.

5-4 Charge and Discharge Operation Effect on Lifetime

Applying a voltage to an aluminum electrolytic capacitor makes the electric charges accumulate on the anode foil dielectric. Discharging the electricity through a discharging resistance makes the electric charges move to the cathode foil and cause chemical reactions between the cathode aluminum and electrolyte, thereby forming a dielectric oxide layer.

When this charge and discharge is repeatedly operated, the chemical reactions proceed to further form the oxide layer on the cathode foil, causing the capacitance of the cathode foil to reduce and thereby reducing the capacitance of the capacitor. Moreover, the chemical reactions bring heat and gases. Depending on the charge and discharge conditions, the internal pressure may increase, the pressure relief vent may open or the capacitor may have destructive failures. Consult us for using a capacitor with the following applications:

- Frequently repeating power on/off.
- Repeating rapid charge and discharge operations at a short interval cycle.
- Repeating charge and discharge operations with a large voltage drop.

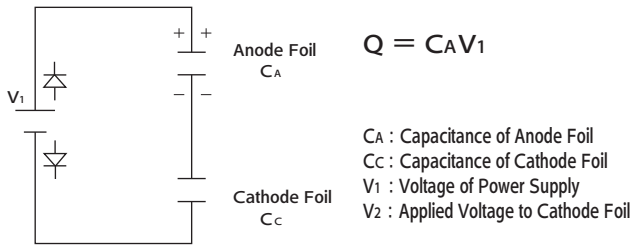

Fig-21 Charge Condition at Charge

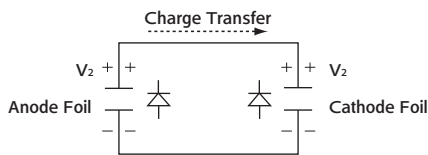

Fig-22 Charge Condition at Discharge (Disconnect V1 and Discharged condition)

$$Q = C_A V_2 + C_C V_2$$

$$\text{then } C_A V_1 = C_A V_2 + C_C V_2$$

$$V_2 = \frac{C_A V_1}{C_A + C_C} \dots\dots\dots (20)$$

Figures 23 through 25 show some test data of special-design capacitors for charge and discharge application, compared with general-purpose capacitors.

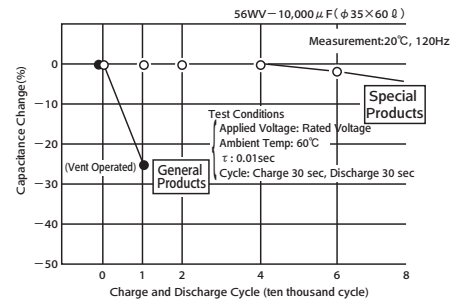

Fig-23 Rapid charge and discharge characteristics (Effects of Frequency)

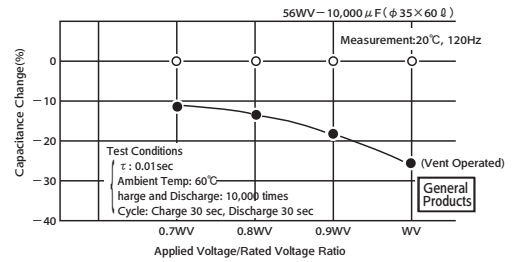

Fig-24 Rapid charge and discharge characteristics (Effects of Applied Voltage)

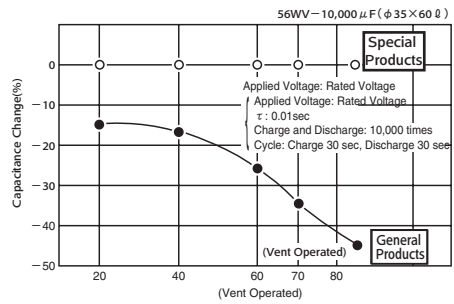

Fig-25 Rapid charge and discharge characteristics (Effects of Ambient Temperature)

5-5 Inrush Current

For the power supply inrush current that can occur on the start-up of a power supply or on the charge of a welding machine lasts only milliseconds, but its magnitude may reach 10 to 1,000 times more than the normal current. Usually, a single, non-repeated inrush current produces a negligibly small amount of heat, so it does not matter.

However, frequently repeating inrush currents may heat up the element inside a capacitor more than the allowable limit and/or overheat the external terminal connections or the connections between the internal lead and foil electrode.

5-6 Abnormal Voltage Effect on Lifetime

Applying abnormal voltage can increase the internal pressure with heat and gases produced, causing the pressure relief vent to open or the capacitor to have destructive failures.

5-6-1 Overvoltage

Applying a voltage higher than the rated voltage will cause chemical reactions (formation of dielectric) to occur on the anode foil with the leakage current rapidly increasing, which produces heat and gases and thereby increases the internal pressure.

The reactions are accelerated by the voltage, current density and ambient temperature, causing the pressure relief vent to open or the capacitor to have destructive failures. It may also accompany a reduction in capacitance and an increase in $\tan \delta$ as well as an increase in the leakage current, which can lead to internal short-circuiting failure. An example of capacitor overvoltage characteristics is shown in Fig. 26.

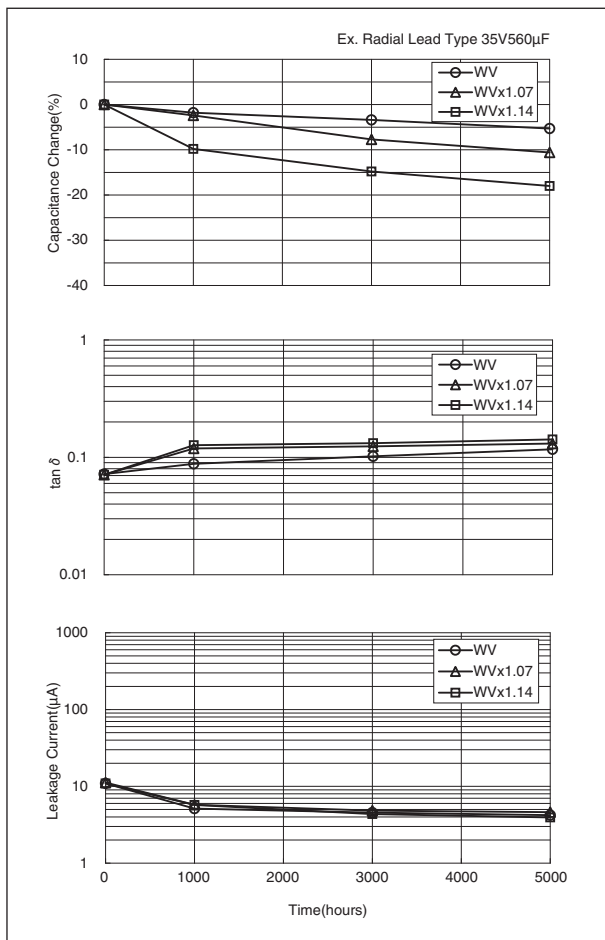

Fig-26 Applied overvoltage characteristic at 105°C

5-6-2 Reverse Voltage

Applying a reverse voltage will cause chemical reactions (formation of dielectric) to occur on the cathode foil, and, as is the case with overvoltage, the leakage current will rapidly increase with heat and gases generating and thus the internal pressure increases.

The reactions are accelerated by the voltage, current density and ambient temperature. It may also accompany a reduction in capacitance and an increase in $\tan \delta$ as well as an increase in the leakage current. An example of capacitor reverse-voltage characteristics is shown in Fig. 27.

A reverse voltage of as small as 1V can cause the capacitance to decrease. A reverse voltage of 2 to 3V can shorten lifetime due to a reduction in capacitance, increase in $\tan \delta$, and/or increase in leakage current. A reverse voltage of even higher value can open the pressure relief vent or lead to destructive failures (Fig. 27).

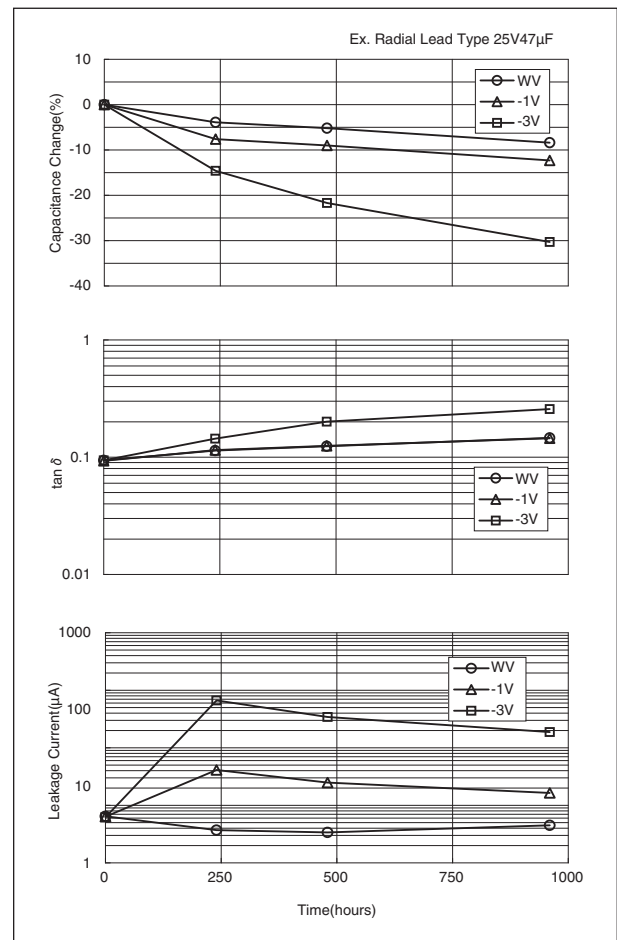

Fig-27 Applied Reverse voltage characteristic at 105°C

5-6-3 Do not Use Aluminum Electrolytic Capacitors in an AC Circuit

Using an aluminum electrolytic capacitor in an AC circuit will result in the same situation as that with a positive potential being applied to the cathode (like a reverse voltage) and with an excessively large ripple current flowing in the capacitor, which may increase the internal pressure due to the generation of heat and gases, open the pressure relief vent, leak the electrolyte with the rubber seal bung expelled or cause the capacitor to blow up or catch fire in the worst case. If the capacitor blows up, it may scatter flammable materials such as electrolyte and element-supporting wax materials, which can lead to short-circuiting of the device. Therefore, do not use aluminum electrolytic capacitors in any of the AC circuits.

6. Effect of Halogens

Aluminum electrolytic capacitors are sensitive to contamination of halogen ions (especially to chlorine and bromine ions) though the degree of the effect depends on the properties of the electrolyte and/or sealing materials used in the capacitors. For using a halide-containing flux, solvent (cleaning agent, adhesive or coating materials) or fumigant, the halide may penetrate into the capacitor through the rubber seal materials and cause the following corrosion reactions to occur. These reactions can lead to an increase in leakage current, opening of the pressure relief vent, and/or open-circuit failure in the capacitor. The reactions are accelerated as the voltage and/or temperature rises.

[Corrosion reactions]

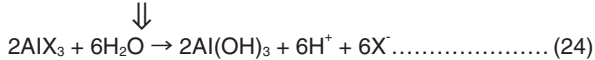
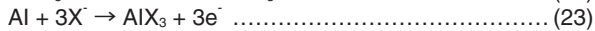
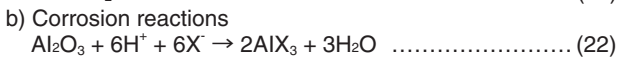
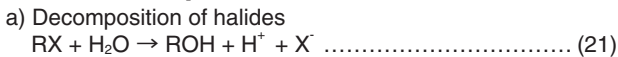

RX : Halogenated compound
 X⁻ : Halogen ions (Cl⁻, F⁻, Br⁻)

Halides that penetrated the element inside a capacitor make contact with the electrolyte, by which the halides are hydrolyzed and release halogen ions as shown on Reaction (21). The halogen ions then attack aluminum by anodic half-cell reaction, producing AlX₃ (Reaction 22 and 23).

AlX₃ is then hydrolyzed, which is decomposed to aluminum hydroxide and the halogen ions (Reaction (24)). The halogen ions reproduced are repeatedly used and reproduced by the reactions of (22) ~ (24), and then the corrosion develops endlessly.

Shown below are precautions for use of flux, cleaning agents, adhesive, coating materials and fumigant.

6-1 Effect of Flux

Usually flux products contain an activator of ionic halide system, which has been associated with the corrosion issues of capacitors, and nowadays non-ionic halide system type flux products have been increasingly available on the market. Some of the latter flux type have been classified into the so called "non-halogen flux" or "halogen-free flux", and parts of the "non-halogen" or "halogen-free" flux products may contain a large amount of non-ionic halides, which can also adversely affect the capacitors.

6-2 Cleaning Agents

Where cleaning the solvent resistance type of aluminum electrolytic capacitors, confirm the following conditions:

- a. Control the contamination (the conductivity, pH, specific gravity, water content, etc.) of the cleaning agents.
- b. After the cleaning, do not leave the capacitors (assembly boards) in an environment of cleaning agent-rich or in a closed container. Sufficiently evaporate the residual cleaning agent from the assembly boards and the capacitors by forced hot air at temperatures less than the upper limit of category temperature range for more than 10 minutes.

In general, aluminum electrolytic capacitors are sensitive to contamination of halogen ions (particularly to chlorine ions). Depending on the properties of the electrolyte and rubber seal materials used in a capacitor, the halogen ions lead up to catastrophic failures on the capacitor. Where the inside of a capacitor has been contaminated with more than a certain amount of halogen ions and the capacitor is in use, the corrosion reaction of aluminum occurs. The corrosion causes the capacitor to have a significant increase in leakage cur-

rent with heat produced, open the pressure relief vent and become open circuit mode failure.

Due to global environmental issues (greenhouse effects and other environmental destruction by depletion of the ozone layer), the conventional cleaning solvents of CFC 113, Trichloroethylene and 1,1,1-trichloroethylene were replaced by substitutes.

6-2-1 Alcohol Cleaning Agents

- ① Fatty-alcohol cleaning agents (New type of solvent)
 Pine Alpha ST-100S (Arakawa Chemical)
 Clean Through 750H, 750K, 750L, and 710M (Kao)
 Technocare FRW-14 through 17 (GE Toshiba Silicones)
- ② IPA (Isopropyl alcohol)

[Compatible capacitor products]

Terminal Shape	Subject Series
Surface Mount Type	All Series
Radial Lead Type	All Series
Snap-in Type	All Series (Less and equal 100V _{dc})

[Cleaning conditions]

Either of Immersion or ultrasonic cleaning, for a maximum of 10 minutes at a maximum liquid temperature of 60°C.

[Precautions]

- a. Make sure that the markings on a capacitor are not rubbed against any other component or the PC board during cleaning. Note that shower cleaning can cause the markings on the capacitor to be washed off.
- b. Depending on the cleaning method, the markings may be erased or blur.
- c. A drying process following a water cleaning or rinsing process may cause the outer sleeve materials of a capacitor to swell or shrink.
- d. After using a weak-alkaline cleaning agent (e.g. Clean Through 750H), rinse with water to make sure that no alkaline residue is left on the capacitor.
- e. Control a flux concentration in a cleaning agent within 2 wt%.
- f. IPS (Isopropyl Alcohol), if containing xylene or other solvent to improve its cleanability, may swell the rubber seal materials.
- g. Depending on the type of cleaning agent or conditions, note that the outer sleeve of a capacitor may lose a gloss or whiten in appearance.

6-2-2 HCFC (Freon-225), as Alternative CFCs AK225AES (Asahi Glass)

[Cleaning conditions]

Solvent resistant type capacitors, which were originally developed to intend to resist Freon TE or Freon TES, are also capable of withstanding either of immersion or ultrasonic cleaning, for a maximum of 5 minutes (or 2 minutes for KRE series or 3 minutes for SRM series). However, in view of global environmental issues, HCFCs has not been recommended.

[Compatible capacitor products]

Terminal Shape	Subject Series
Surface Mount Type	MVA(~63V _{dc}), MVE(~63V _{dc}), MZS, MZL, MZR, MZJ, MZA, MVY(6.3 ~ 63V _{dc}), MZF, MZE, MZK, MLA, MLF, MLE, MLK, MVL, MVJ, MHS, MVH(~50V _{dc}), MHL, MHB, MHJ, MXB, MHK
Radial Lead Type	SRG, KRG, KMQ(~100V _{dc}), SMG(~250V _{dc}), KMG(~250V _{dc}), LZA, LXZ, LXV, LXV, LE, GPA, GVA, GXF, GXE(~50V _{dc}), GXL, GPD, GVD, GQB, LBV, LBG

When a capacitor is mounted closely flush on the PC board, a residual cleaning agent may be left in the gap between the body of the capacitor and PC board surface. Dry out the residue with a forced hot air of 50 to 85°C for 10 minutes or more.

6-2-3 Other Solvents

To avoid capacitor failures, do not use the following cleaning agents:

- Halogenated system: causes capacitor failures due to corrosion.
- Alkali system: corrodes (dissolves) the aluminum can case.
- Terpene and petroleum system: deteriorates the rubber seal materials.
- Xylene and toluene: deteriorates the rubber seal materials as well.
- Acetone: erases the markings printed on a capacitor.

6-3 Adhesive and Coating Materials

To use adhesives and/or coating materials for aluminum electrolytic capacitors, make sure of the following conditions:

- Do not use any of adhesive or coating materials containing halogenated solvents.
- No flux residue nor stain is left between the rubber seal of a capacitor and PC board.
- Dry the capacitor to remove residual cleaning agents before applying adhesive and coating materials. Do not cover up the entire surface of the rubber seal of the capacitor with adhesive and coating materials.
- Improper heating and/or curing conditions for adhesives and coating materials may cause the sleeve to swell or shrink. Please consult us for proper conditions.
- For a non-solid aluminum electrolytic capacitor, covering up

the entire surface of the rubber seal with resin mold materials will obstruct the normal diffusion of internal hydrogen gas from the capacitor and result in serious failures. Also, where the adhesive and coating materials contain a large amount of halogen ions, the halogen ions will contaminate the inside of the capacitor through the rubber seal materials, which cause the capacitor to become a failure.

- The outer sleeve of a capacitor may lose a gloss or whiten in appearance depending on solvent materials that the adhesive or coating materials contains.
- Some adhesives or coating materials contain organic solvent such as Xylene. Xylene can deteriorate the rubber seal materials, which cause the flux ingredients to penetrate into the capacitor.

6-4 Effect of Fumigation

In exporting or importing electronic devices, they may be exposed to fumigation with halide such as methyl bromide. Where aluminum electrolytic capacitors exposed to halide such as methyl bromide, the capacitors will be damaged with the corrosion reaction with the halogen ions.

For the export and import, Nippon Chemi-Con considers using some packaging method and so forth that the fumigation is not required to. For customers to export or import electronic devices, semi-assembly products or capacitor components, confirm if they will be exposed to fumigation and also consider final condition of packaging. (Note that either cardboard or vinyl package has a risk of fumigation gas penetration.)

7. Recovery Voltage

Where a capacitor is once charged and discharged with both of the terminals short-circuiting and then left the terminals open for a while, a voltage across the capacitor spontaneously increases again. This is called "recovery voltage phenomenon". The mechanism for this phenomenon can be interpreted as follows:

When charged with a voltage, the dielectric produces some electrical changes within, and then the inside of the dielectric is electrified with the opposite polarities (dielectric polarization).

The dielectric polarization occurs in both ways of proceeding rapidly and slowly. When a charged capacitor was discharged until the voltage across the capacitor disappears, and then being left the terminals open, the slow polarization will discharge within the capacitor and appear as recovery voltage. (Fig. 28).

The recovery voltage changes with time as shown in Fig. 29. Its peak will appear 10 to 20 days after the terminals are opened, with gradual weakening thereafter. Larger sized capacitors (screw terminal type and snap-in type) may produce larger recovery voltage.

With a recovery voltage residing in a capacitor, carelessly short-circuiting the terminals can cause sparks to occur, which may scare workers and/or damage low-voltage operating components such as CPU's and memories in the device circuit. To avoid this trouble, discharge the capacitor through 100 - 1kΩ resistors before use. Also, Nippon Chemi-Con may provide some solutions with some packaging method for it. Please consult us.

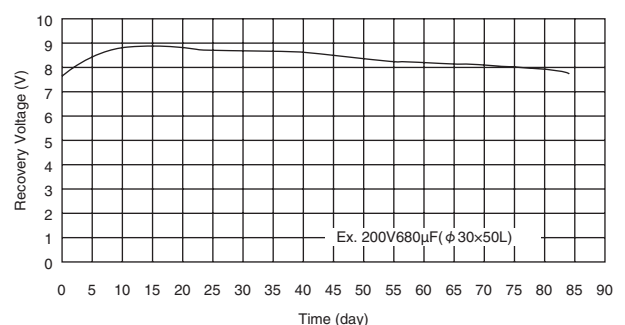
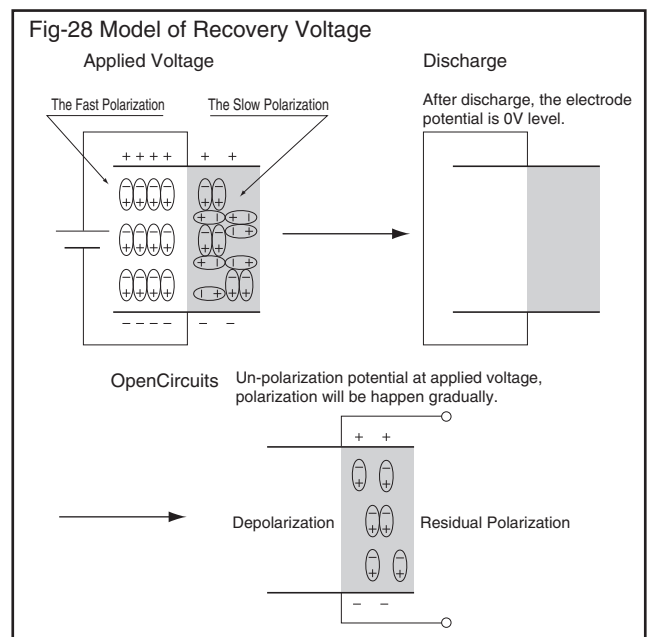

Fig-29 Change of Recovery Voltage

8. Storage

Some characteristics of an aluminum electrolytic capacitor are temperature-dependent. The higher the temperature is, the more deteriorated the capacitor will be. An increase in temperature accelerates the increase in leakage current and $\tan\delta$ and the decrease in capacitance. Leaving a capacitor exposed to high humidity for long hours may lead to discoloration of the lead wires and terminals, and poor solderability. To store aluminum electrolytic capacitors, keep them at normal temperature and humidity without exposure to direct sunlight.

Leaving them exposed to high temperatures (higher than the normal ambient temperature) for long periods of time may lead to chemical reactions between the anode oxide layer and electrolyte, which drop the withstanding voltage and increase leakage current. If this is the case, applying the rated voltage to the capacitor will lead to dielectric breakdown due to the heat produced with the large leakage current, which finally causes the pressure relief vent to open.

Capacitors that have been stored for long periods of time should be subjected to a voltage treatment process (see Note 1) which will reform the dielectric (Al_2O_3) by electrolyte and return the leakage current to the initial level. Leakage current increase during storage will vary with the withstanding voltage of a capacitor. In general, the higher the rated voltage, the larger increased the leakage current tends to be. Also, since storing for long period of time may shorten the lifetime of the capacitors, consider storage conditions according to the requirements of device life expectancy.

(Note 1) In the voltage treatment process, connecting resistor (around $1k\Omega$) in series with the capacitor, applied the rated voltage and then be kept the rated voltage for 30 to 60 minutes.

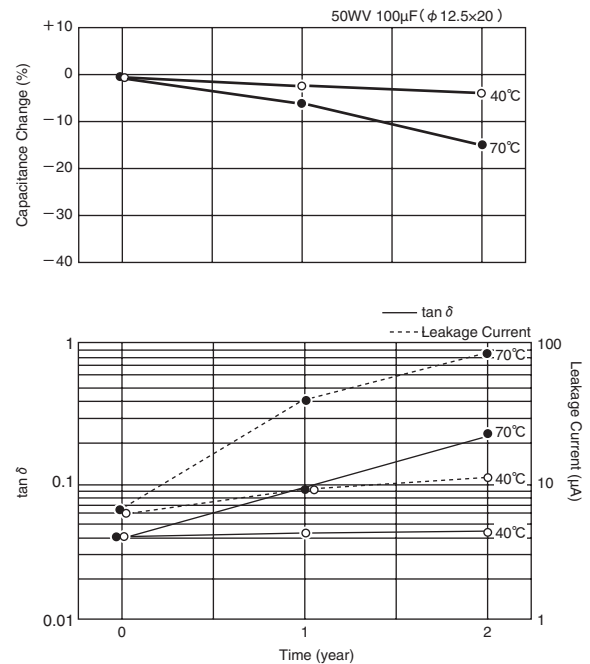

Fig-30 Temperature Characteristics of Storage

9. Tips for Selecting Capacitors Appropriate for Individual Applications

Aluminum electrolytic capacitors are used mainly for the filtering application of power supplies. Select appropriate capacitors for the specific requirements of each application, referring to the following examples for typical applications:

9-1 Input Filtering Capacitors for Switching Mode Power Supplies

An input filtering capacitor functions to smooth 50-120 Hz waveforms that come from a rectifying circuit, the waveforms of which are superimposed with the ripples with the switching frequency from the switching stage where the capacitor supplies the electric power. Therefore, the capacitor must be capable of managing both ripple currents with each frequency. The ESR of a capacitor is frequency-dependent, so that a ripple current of different frequency produces a different thermal energy in the capacitor.

For PFC power supplies or lighting ballasts, capacitors are subjected to ripple current whose frequency is several dozens of kHz to 100kHz. Therefore, to select capacitors, take their impedance characteristics into consideration.

● Recommended input filtering capacitors for SMPS

Characteristics Type	85°C		105°C		
	Standard	Longer Life	Standard	Compact	Longer Life
Radial Lead	—	—	KMQ	PAG	KXJ
Snap-in	SMQ	SMM	KMQ	KMS,KMR	LXS,LXM

9-2 Output Filtering Capacitors for Switching Mode Power Supplies

In the output filtering, a capacitor must be capable of managing a ripple current with the frequency as high as around 100 kHz. Therefore, Nippon Chemi-Con provides excellent product line-ups with low impedance characteristic at high frequencies, including high temperature and long-life versions, which can be chosen according to the application purpose.

The 125°C maximum temperature series capacitors have a shorter lifetime than the “Long Life” series of 105°C max. temperature though the electrical characteristics are highly stable. The “wide temperature range” series has two subseries that differ by the applicable temperature range: -55 to 105°C and -40 to 125°C. The “Long Life” series capacitors have been designed for specializing lower impedance and also longer lifetime. Compared to the “wide temperature range” series, the Long Life series can serve longer with the lower impedance, though the maximum operating temperature is limited to 105°C and the electrical characteristics are large in change over the temperature range.

● Recommended output filtering capacitors for SMPS

Characteristics Type	105°C		125°C
	Standard	Low Z	High Temp
Wide Temp Range	LXY	LXZ	GXE
Longer Life	KY	KZM,KZN	—

9-3 Filtering Capacitors for Inverter Main Circuits

These capacitors are used in a similar way to those for the input of the switching mode power supplies. Additionally, please understand the following precautions:

For the filtering circuit for 400Vac line, two capacitors of each a rated voltage 350 to 400Vdc can be used with being connected in series. In the series connection, voltages across the individual capacitors during charging depend on their individual capacitance values. After completion of the charging, the voltages come to depend on their leakage current values as the voltage distribution to the individual capacitors inversely corresponds to their leakage current values. For the voltage not to exceed the rated value after the charging is completed, balancing resistors should be connected in parallel with each capacitor. For guidance on choosing balancing resistors, please consult us.

Where capacitors connected in series are frequently charged and discharged, individual charging voltages depend on the variations in their capacitance values. Therefore, keeping the voltage balance will be difficult even if balancing resistors are employed. For servo amplifiers and other application where the voltage fluctuates frequently due to regeneration, use capacitor families that have been especially designed for intensive charge and discharge operations, or consult us for individual designs.

● Recommended capacitors for inverter main circuits

Characteristics Type	85°C		105°C	
	Standard	Longer Life	Standard	Longer Life
Snap-in	SMQ	SMM	KMQ	LXS,LXM
Screw Mount	RWE	RWF,RWH	KMH	LXA,LXR

● Recommended capacitors for servo amplifiers

Characteristics Type	85°C	105°C
	Standard	High Temp
Snap-in	—	KMV
Screw Mount	RWV	—

9-4 Capacitors for Control Circuits

These capacitors are relatively small in capacitance, and therefore the case size is also small. However, the smaller the case size, the shorter the lifetime of a capacitor. Moreover, if a capacitor is located near a heat source, the capacitor’s lifetime may be shortened. Consider selecting an adequate capacitor in lifetime balancing with other capacitors.

● Recommended capacitors for control circuits

Characteristics Type	105°C
Radial Lead	KY,KYB,LE

9-5 Photoflash Capacitors

These capacitors are specially designed so that much higher energy-volumetric efficiency can be obtained. Therefore, these capacitors are limited in application. Note that they cannot substitute filtering capacitors. Detailed specifications of these capacitors should be determined specifically for each photoflash application through discussions with a customer.